

YAMAHA
ROBOT
LINEUP CATALOG



IM Operations
882 Soude, Naka-ku, Hamamatsu, Shizuoka 435-0054, Japan
Tel 81-53-460-6103 Fax 81-53-460-6811

URL <http://global.yamaha-motor.com/business/robot/>
E-mail robotn@yamaha-motor.co.jp

YAMAHA ROBOT

History and approach

30 years of proven reliability.

YAMAHA's robot development started as it was introduced in our motorcycle production line more than 30 years ago.

Since then, YAMAHA's industrial robots have supported production equipment in a wide variety of industries, such as assembly of electronic products, transfer of in-vehicle components, and manufacture of large-scale LCD panels.

Over the years YAMAHA has striven to develop and improve the market and this is a testament to YAMAHA's reliability.



Technical development based on the originally developed technologies and focusing on the needs of the market

"Motor control technology" absolutely necessary for precise and high-speed operation "Controller development technology" is based on the highest evaluation standards and Signal processing technology allowing stable operation even under extreme environmental conditions.

Rigidity, durability, and operability are features of YAMAHA's products base on "Coretechnologies".

*Control boards, linear motors, and linear scales (position detectors), etc.



Evaluation system provides high reliability

YAMAHA continues to evaluate technology to assure product reliability.

In the product development phase, the evaluation test at "anechoic chamber" (YAMAHA's equipment) was developed to ensure the high reliability and quality.

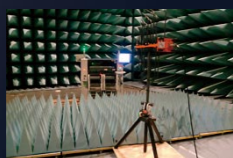

*Anechoic chamber: This equipment is intended to synthetically develop the EMC (Electro-Magnetic Compatibility) technologies for YAMAHA Group products and to share the developed technologies. This equipment can evaluate the compliance with each country's regulation in conformity with the international standards.

YAMAHA quality ensuring safety

Manufacturing, sales, and technology integrated system is utilized at its maximum level to establish a system that consistently performs a series of processes: inspection → manufacture → assembly → inspection → shipping. This can provide the customers with high quality, low price, and short delivery time.

Key components are manufactured through in-house processing and machining. YAMAHA as a robot manufacturer builds the components to the highest quality level. Furthermore, the quality control based on the severe standards achieves the craftsmanship with high quality.

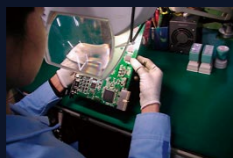

TRANSERVO Series

CLOSED LOOP STEPPING MOTOR SINGLE-AXIS ROBOTS

Quick selection table ▶▶ P18



Compact & economical single-axis robot, TRANSERVO series, with cost of the stepping motor and function of servo motor.

The position detector is a resolver

The position detector is a resolver. The resolver has a simple yet strong structure using not electronic components or elements and so has great features such as being extremely tough in harsh environments as well as a low breakdown rate. The resolver structure has none of the detection problems that occur in other detectors such as optical encoders whose electronic components break-down or suffer from moisture or oil that sticks to the disk.

SS Slide type



SG Slide type



SR Rod type



STH Slide table type

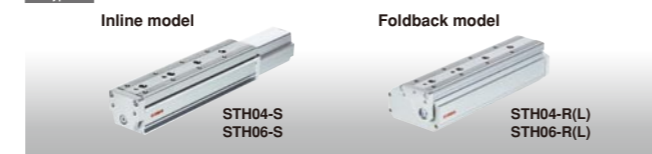

RF Rotary type

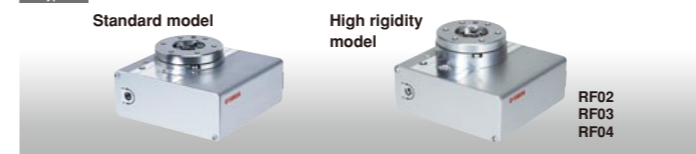

BD Belt type



Closed-loop control for position feedback

Stepping motors provide great features such as low cost, yet they have a drastic drop in torque at high speeds and heavy current consumption when stopped.

The TRANSERVO by YAMAHA eliminates all these problems by adopting an innovative vector control method. In effect, the TRANSERVO delivers the same functions of a servo motor while using a lower cost stepping motor.

Stepping Motors	<ul style="list-style-type: none"> •Simple design & low cost •No vibration when it stops 	<ul style="list-style-type: none"> •High-pitched operating noise •Drop in torque at high-speed •heavy current consumption when stopped.
Servo Motors	<ul style="list-style-type: none"> •Smooth movement •Constant torque at all speed range •Energy saver 	<ul style="list-style-type: none"> •Dithering •Cost is high

TRANSERVO is combines the best features of both types

SG type (Slider type) Features & Benefits

Dynamic payload capacity of 46 kg (horizontal) and 20 kg (vertical)



Maximum speed of 1200 mm/sec.

current model SS05H	Maximum speed 1000mm/sec
SG07	Maximum speed 1200 mm/sec

SS type (Slide type) Features & Benefits

High-speed operation slashes production time

Optimizing vector control method, the TRANSERVO maintains a constant payload even in the high-speed range. This helps to drastically cut down on the tact time. By combining this feature with high-lead ball screws, the TRANSERVO has achieved a maximum speed of 1 meter per second^{note} which is as fast as single-axis servo motors in the same category.

Note : SS05/SS05H/SSC05/SSC05H (Lead20mm)

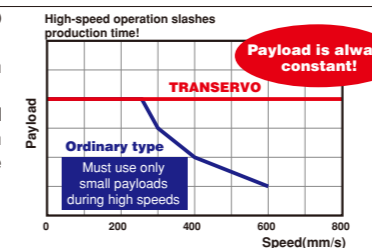

Ideal 4-row circular-groove 2-point contact guide provides longer service life

The guide maintains a satisfactory rolling movement with minimal ball differential slip, even if a large momentum load is applied or the installation surface accuracy (flatness) is bad. The rugged design ensures that breakdowns from problems like abnormal wear will seldom occur.

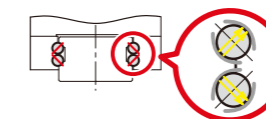

SR type (Rod type) Features & Benefits

Long-term maintenance free

A lubricator used in the ball screw and a contact scraper provides long-life and maintenance-free operation. maintenance free operation.

- Needs no maintenance for long periods
- Grease-saving lubrication system
- Prevents contaminant particles

Uses highly reliable resolver

A rugged and sturdy resolver is used as the position sensor. All models are selectable with a brake.

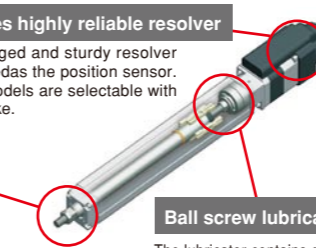

Layered contact scraper

The dual-layer scraper prevents micro-contaminants adhering to the rod from penetrating to the inside. This is also effective in suppressing looseness or vibration in the rod.

Ball screw lubricator

The lubricator contains grease in a high-density fiber net so that it supplies just the right amount of grease where needed with no waste.

STH type (Slider table type) Features & Benefits

Circulation type linear guide for high rigidity and accuracy

Maximum pressing force 180N, Repeatability ±0.05mm. Integration of the guide rail and slider, this ensures less deflection. The circulation type linear guide makes it possible to provide high rigidity and accuracy. "STH06" provides an allowable overhang that exceeds "T9" of the FLIP-X series. Also, foldback models with the side mounted motor built into the body. The STH type is optimal for precise assembly.

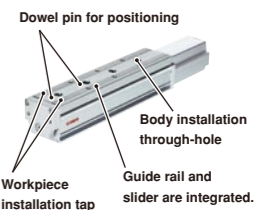

RF type (Rotary type) Features & Benefits

First rotation axis model in TRANSERVO series

Maximum speed 420°/sec, Repeatability ±0.05°. The RF type is a thin and electric rotary type actuator. The two model types, standard type and high rigidity type, can be selected as the optimal applications. The RF type has very easy-to-use specifications that allow easy installation of the workpiece on the table and installation on the base frame. This type can be used for the rotation transfer after chucking or the vertical rotation operation by combining it with the gripper.

High rigidity type bearing reduces the free play in the radial and thrust directions of the table.



BD type (Belt type) Features & Benefits

For long stroke applications

Maximum stroke 2000mm, Maximum speed 1500mm/sec. This type is applicable to a long stroke of up to 2000 mm. The maximum transfer speed is 1500 mm/sec., ensuring high-speed operation. The main body can be conveniently installed without removing exterior parts, such as the cover. Additionally, the shutter is provided as standard accessory. It covers the guide and belt securely to prevent grease from scattering and to block entry to external foreign objects. This type is optimal for workpiece positioning or long-distance transfer.

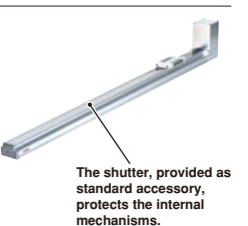

FLIP-X Series

SINGLE-AXIS ROBOTS

Quick selection table ▶▶ P19



Single-axis robot series include 6 types and 29 variations for a wide range of selections.

T Compact model

type T4L/T4LH, T5L/T5LH, T6L, T9/T9H

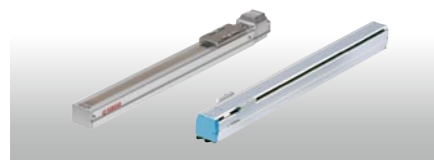

Double appeal of a compact body and low price. Ideal in applications as an actuator directly installed on a mount.

N Nut rotation model

type N15/N15D, N18/N18D

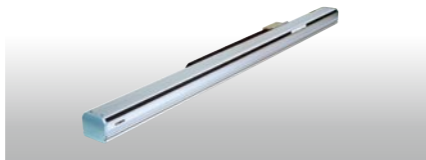

The operation can be made even at a long stroke while keeping the maximum speed without being affected by the critical speed. Double carrier specifications are also available as a standard.

F GF High rigidity model

type F8/F8L/F8LH, F10/F10H, F14/F14H, F17/F17L, F20/F20N, GF14XL/GF17XL



Highly rigid aluminum frame is used, allowable load moment is large, and resistance to the offset load is provided. This model is suitable for the Cartesian robot that needs the rigidity for the arm and the moving arm that moves the overall axis.

B Timing belt drive model

type B10, B14/B14H

Maximum stroke length of 3050mm. Allows long distance transport between job processes.

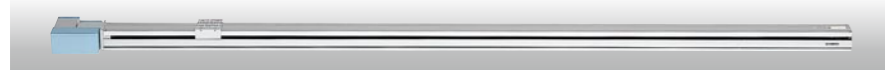

R Rotary axis model

type R5, R10, R20

Position repeatability accuracy of +/-30seconds (0.0083"). The R type can be used as the rotation axis when combined with other robots, or utilized for a wide range of applications such as index tables. Harmonic drive delivers high-strength and high-accuracy.



Resolver with excellent environmental resistance capability



Resolver with high reliability is adopted to detect the motor position. This enables stable position detection even in a harsh environment where powder particles or oil mists exist. Additionally, a high resolution of 20480 pulses per revolution is provided.

Optical encoder



- Optical
- Electronics parts are required and structure is complicated.
- Electronics part trouble, disc dew condensation, or oil sticking occurs easily.

Risk of detection failure

Resolver

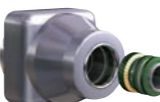

- Magnetic type
- Simple structure with only the iron core and winding ensures less potential failure.
- Highly resistant to impact and electric noise.

High reliability

Custom order specifications for each model are available.

We gladly accept special orders for all models such as for double sliders or wide sliders. Please consult with our sales office for more information.

4-row circular-groove 2-point contact guide to support large moment load.



4-row circular-groove 2-point contact guide with less differential slip is adopted. According to its structure, the differential slip of the ball is small when compared to the 2-row gothic-arch-groove 4-point contact guide. This guide maintains excellent rolling motion even when a large moment load is applied or the installation surface accuracy is poor, and has characteristics that are difficult to produce a malfunction, such as unusual wear.

Conventional 2-row gothic arch groove 4-point contact guide

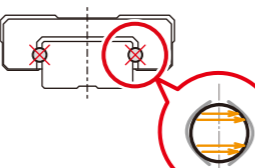

Large differential slip, and large friction resistance

- Very susceptible to effects from poor installation precision, friction and elastic deformation
- Might break even within the calculated service life.

YAMAHA's 4-row circular arc groove 2-point contact guide

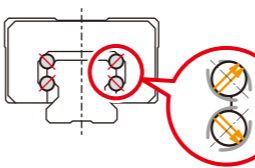

Small differential slip and good self-centering

- Highly resistant to alignment fluctuations and moment loads
- Resistant to breakage

Long-service life greatly reduces the maintenance and control costs.

YAMAHA's highly rigid ball screw or guide greatly contributes to reduction of the customer's maintenance and control costs. The service life can be calculated based on the grounds at YAMAHA's website.



PHASER Series

LINEAR MOTOR SINGLE-AXIS ROBOTS

Quick selection table ▶▶ P18



No speed deration needed up to 4m long stroke. Delivers superb performance in long distance transport.

MF Long stroke & high-power using flat motor with core

type Double Carriages Standard on all Modules

- Maximum stroke : 4050mm
- Maximum speed : 2500mm/s
- Repeated positioning accuracy : ±5μm
- Maximum payload : 7 to 160kg

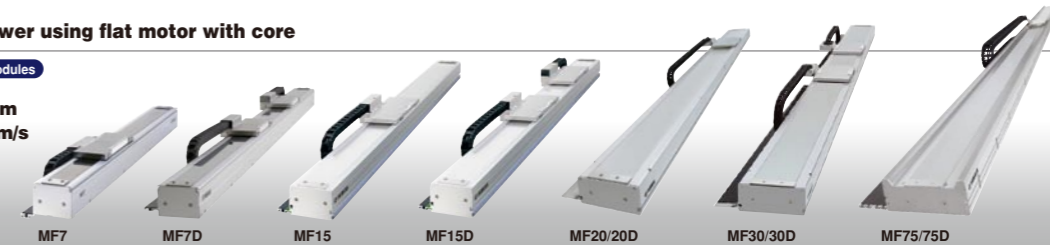

MR Shaft motor drive with the advantages of a light-weight compact body · minimal cogging

type Double Carriages Standard on all Modules

- Maximum stroke : 1050mm
- Maximum speed : 2500mm/s
- Repeated positioning accuracy : ±5μm
- Maximum payload : 5kg

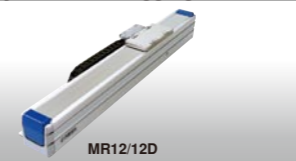

Low cost by YAMAHA's in-house design components.

YAMAHA originally developed the magnetic scale and still manufactures it. As YAMAHA also manufactures other major components, large cost reduction is achieved. Today is an era that the linear is not a special mechanism and can be appropriately selected in comparison to the ball screw.

Particularly, when transferring a lightweight workpiece a long distance at a high speed, selecting the linear motor type will reduce the cost.

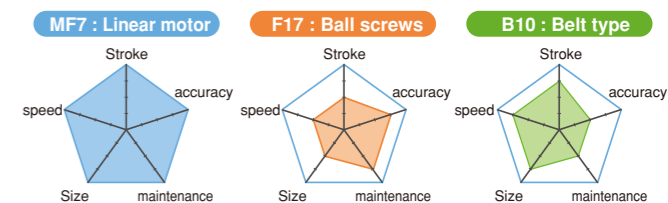

Comparison of single-axis robot models

Model	Unit Cost ^{Note1}	Maximum speed (mm/sec)	Payload (kg)	Repeatability (μm)	Maximum stroke (mm)	Frame dimension ^{Note2} (mm)
MF7-1500		2500	10(7) ^{Note3}	±5	4000	W85xH80
F17-40-145		720 ^{Note4}	40	±10	1450	W168xH100
B10-1450		1850	10	±40	2550	W100xH81

Note1 : Comparisons when using the strokes shown above Note2 : No flexible cable guide is included. Note3 : This value becomes 7kg when the maximum speed is 2500mm/s (2100mm/s when transferring 10kg). Note4 : This value considers the critical speed when the stroke is 1450mm.

High speed, Long Travel

The ultimate appeal of linear motor single-axis robots is that there is no critical speed limits such as with ball screws. There is no reduction in the maximum speed even when traveling long distances. Moreover, the maximum stroke is a standard setting of up to 2m on the MR type and to 4m on the MF type. The cycle time in particular for long distance conveyance has been drastically improved

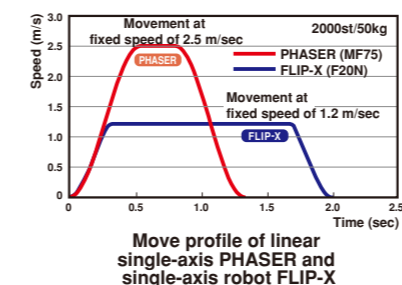

Standard double carrier set-up for space saving and high efficiency.

Cost and space are reduced when compared to the use of two single-axis robots. Additionally, the axis alignment is not needed and the tools can also be made common. This shortens the setup time. (When using the RCX series controller, the anti-collision control function can be used.)

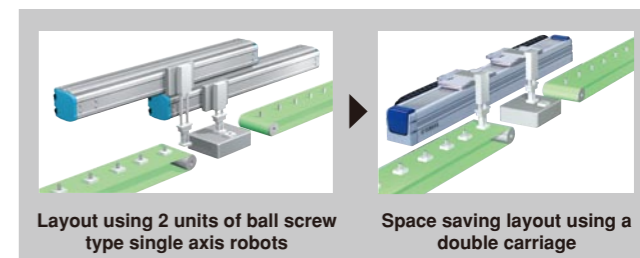

160 kg maximum payload capacity of MF Series

The MF series robot adopts the flat type magnet. It can transfers a heavy object at a high speed with a high accuracy.

Lower noise level and longer life

Comparing with ball screw type robots, there are few sliding and rotating sections so the operation is amazingly quiet. Moreover the coil and magnet do not make contact so there is no wear and the robot can be used for extended periods.

XY-X Series

CARTESIAN ROBOTS

Quick selection table ▶▶ P19



MULTI-FLIP / MULTI-PHASER

MULTI-AXIS ROBOT

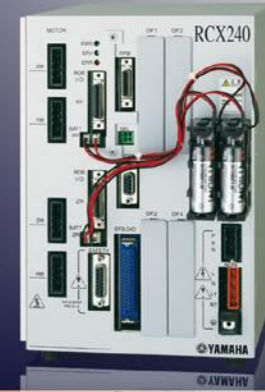

Wide variety of pre-configured multi-axis systems to choose from.
From compact economical light duty to Large heavy duty systems.

Custom orders

Custom designed multi-axis system is available. Please consult nearby YAMAHA representatives.

Arm type



Gantry type

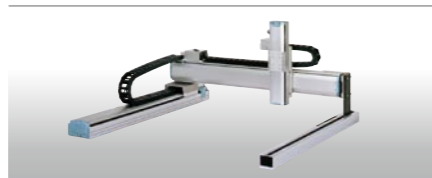

Moving arm type

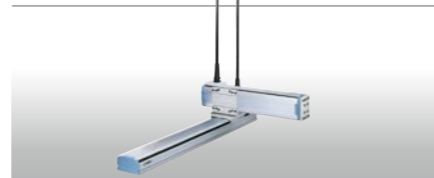

XZ type



Pole type



Dual-synchronous drive

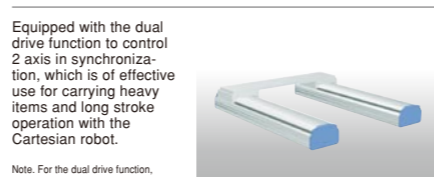

Equipped with the dual drive function to control 2 axis in synchronization, which is of effective use for carrying heavy items and long stroke operation with the Cartesian robot.

Note: For the dual drive function, custom order arrangement is required.

Various variations



Models with 3 or more axes can be selected from:
● Z-axis clamped base and moving table type
● Z-axis clamped table and moving base type

Durable and Reliable Position Detection: Resolver



The position detector is a resolver. The resolver has a simple yet strong structure using non-electronic components or elements and so has great features such as being extremely tough in harsh environments as well as a low breakdown rate. The resolver structure has none of the detection problems that occur in other detectors such as optical encoders whose electronic components breakdown or suffer from moisture or oil that sticks to the disk. Moreover, **mechanical specifications for both absolute and incremental are common to all controllers** so one can switch to either absolute or incremental specifications just by setting a parameter. Also, even if the absolute battery is completely worn down, the XY-X can operate on incremental specifications so in the unlikely event of trouble one can feel secure knowing that there will be no need to stop the production line. The backup circuit has been completely renovated and now has a backup period extending to 1 year.

Economy Solution

We achieved an even lower price by cutting down the number of parts while boosting basic performance. Using a resolver in the structure helped to finally eliminate the "absolute units are expensive" idea. Moreover, the mechanical components are the same regardless of whether incremental or absolute unit specifications are used.

Field Serviceable Structure

Even though it uses a built-in structure, components such as the motor and ball screw can be replaced individually so maintenance tasks are smooth and simple.

4-row 2-point groove guide rail for superb durability.



4-row circular-arc-groove 2-point contact guide with less differential slip is adopted. When compared to the 2-row gothic-arch-groove 4-point contact guide, the 4-row circular-arc-groove 2-point contact guide has characteristics that the differential slip of the ball is small due to its structure and excellent rolling motion is maintained even when a large moment load is applied or the installation surface accuracy is poor. So this guide is difficult to produce a malfunction, such as unusual wear.

2-row gothic arch groove 4-point contact guide

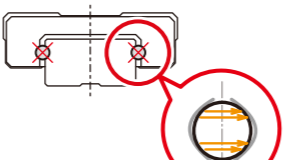

Large differential slip, and large friction resistance

- Very susceptible to effects from poor installation precision, friction and elastic deformation
- Might break even within the calculated service life.

4-row circular arc groove 2-point contact guide

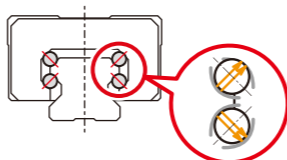

Small differential slip and good self-centering

- Highly resistant to alignment fluctuations and moment loads
- Resistant to breakage

One controller for multiple single-axis robots.

The advantage of multi-axis controller operation

- Sequence control is simple. System upgrades are inexpensive.
- More compact and saves more space than when operating multiple single-axis controllers.
- Allows more sophisticated control.
- Multi-axis controllers RCX221/RCX240 provide mixed control of the (linear single-axis) PHASER series and FLIP-X series.



[Example] 4 axes controller

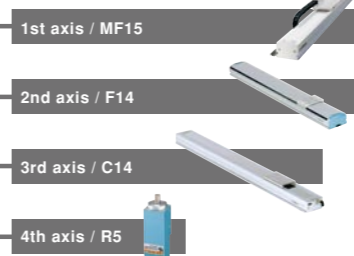

Robot set-up

2-unit robot setting: Using a multi-task program along with this 2-unit setting allows asynchronous independent operation. Using this along with an auxiliary axis setting allows even more freedom in assigning axes to tasks.

Synchronized double carrier:

This setting allows adding 2 motors to 1 axis on robot types where the motor unit runs separately such as the linear motor single-axis PHASER series or the N-type (nut rotation type) FLIP-X series.



Main auxiliary axis setting:

Use this auxiliary axis setting when simultaneous movement with the MOVE command is impossible. An axis set for the main auxiliary axis moves only by the DRIVE command (axis separate movement command) and cannot operate from the MOVE command. Using this setting is recommended for operating on an axis that is not synchronized with the main robot.

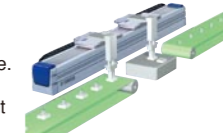

Synchronized dual setting:

Make this setting when operating dual-drive (2-axis simultaneous control). Use this dual-drive setting on gantry type Cartesian robots having a long Y axis stroke when stabilizing at high acceleration/deceleration or when high-thrust is needed with high loads.

YP-X Series

PICK & PLACE ROBOTS

Quick selection table ▶▶ P22

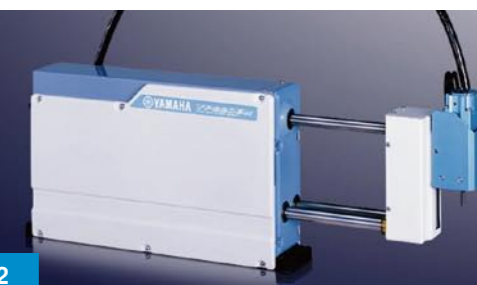

Ideal for high-speed pick & place tasks of small parts.
Positioning by servo control to eliminate mechanical adjustment.

2 axes type

YP220BX
YP320X

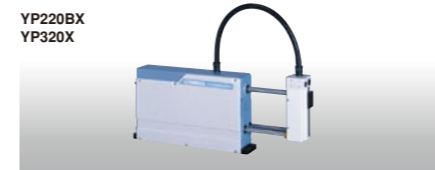

3 axes type

YP220BXR
YP320XR
YP330X



2 axes type

YP340X

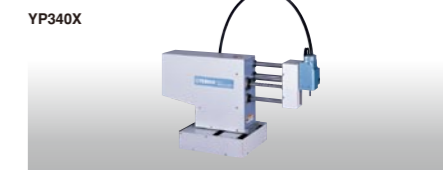

High speed

High speed pick & place operation contributes largely to higher productivity. YP220BX under operation conditions of 50mm in vertical direction, 150mm in longitudinal direction, 50 in arch volume and 1kg load can achieve a total cycle time or .45 seconds.

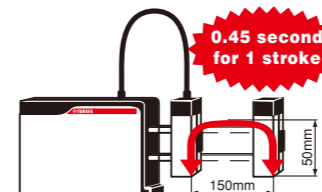

High repeatability

Both extremely high-speed performance and high repeatability of +/-0.02mm (YP320X, YP320XR, YP330X, YP340X) are assured.

Compact size

Compact size with an overall length of 109mm (YP220BX) and moving arm mechanism enable construction of a space saving production line with less interference with surroundings.

YK-X Series

SCARA ROBOTS

- YK-XG Direct Drive beltless model
- YK-XR Low cost high performance model
- YK-XGS Wall mount/inverse model
- YK-XGP Dust-proof & drip-proof model

Quick selection table ▶▶ P20



Arm length of 120mm to 1200mm. Widest selection in industry. High-speed high-precision operation contributes to increased productivity.

Tiny type SCARA model

YK120XG, YK150XG
YK180XG, YK220X

- Arm length : 120mm to 220mm
- Maximum payload : 1kg

Using a completely beltless structure exclusively this class, even ultra-small model achieves the high rigidity and high accuracy. By increasing the maximum motor rpm, the maximum speed is improved remarkably when compared to the conventional model.

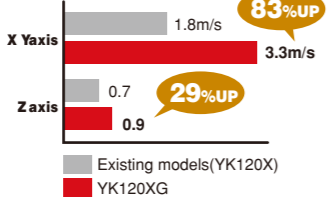

Medium type

YK250XG
YK350XG
YK400XG

- Arm length : 250mm to 400mm
- Maximum payload : 5kg

YK400XR

- Arm length : 400mm
- Maximum payload : 3kg

Wall-mount / inverse model

YK300XGS, YK400XGS
YK500XGS, YK600XGS
YK700XGS, YK800XGS
YK900XGS, YK1000XGS

- Arm length : 300mm to 1000mm
- Maximum payload : 20kg



Wall-mount type
Type where the robot body is installed in the wall.

Inverse type
Type where wall-mount type is mounted upside down.

Medium type

YK500XGL / XG
YK600XGL / XG/XGH

- Arm length : 500mm to 600mm
- Maximum payload : 5kg to 20kg



Large type

YK700XGL
YK700XG
YK800XG
YK900XG
YK1000XG
YK1200X

- Arm length : 700mm to 1200mm
- Maximum payload : 10kg to 50kg

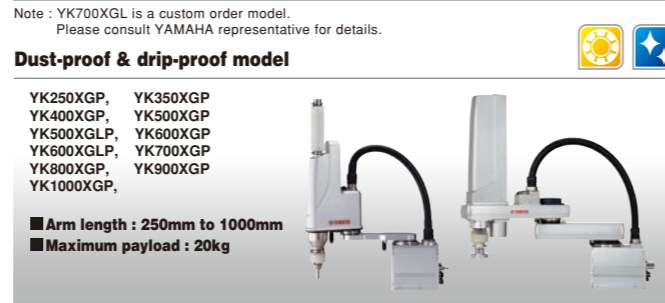

Designed for applications in environment with water splash and dust (protection class equivalent to IP65).
● Please consult us for anti-droplet moisture protection for anything other than water.
Note : YK700XGP/YK800XGP/YK1000XGP is a custom order model.
Please consult YAMAHA representative for details.

Internal structure designed for optimal operation

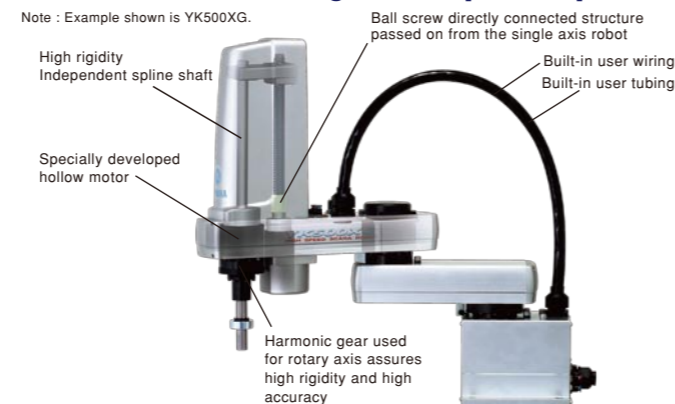

30 Years of history

The first robot YAMAHA released was SCARA robot. Since that first SCARA robot called "CAME" was produced in 1979, some 30 years of SCARA robot innovations have been developed. These SCARA robots have undergone countless modifications in an ever-changing marketplace and amassed a hefty record of successful products making them an essential part of the YAMAHA robot lineup.



Completely beltless structure

A totally beltless structure was achieved by using a ZR axis direct coupling structure. This direct drive structure drastically reduces wasted motion. It also maintains high accuracy over a long period of time. It ensures maintenance-free usage for extended periods with no worries about belt breakage, stretching or deterioration with age (feature applies to all XG series models and the YK180X/YK220X).

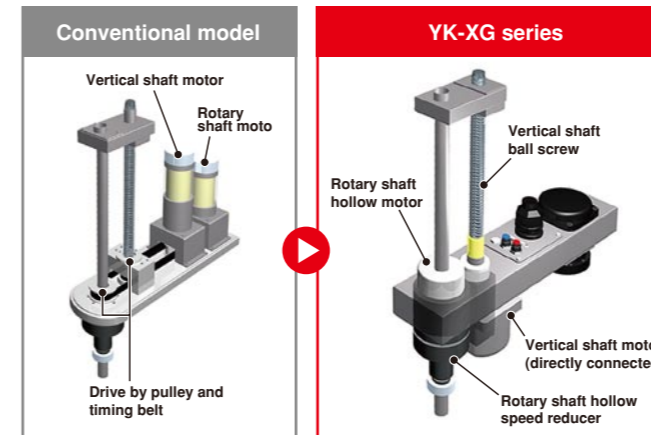

Environmentally rugged resolver provides closed loop control

The position detector is a resolver. The resolver has a simple yet strong structure using not electronic components or elements so these features make the structure extremely tough in harsh environments with a low breakdown rate. The resolver structure has none of the detection problems that occur in other detectors such as optical encoders whose electronic components breakdown or suffer from moisture or oil that sticks to the disk. Moreover, **mechanical specifications for both absolute and incremental are common to all controllers** so one can switch to either absolute or incremental just by setting a parameter.

Also if the absolute battery is completely worn down, the SCARA can operate on incremental. In the unlikely event of trouble one can feel secure knowing that there will be no need to stop the production line. The backup circuit has been completely renovated and now has a backup period extending to 1 year.

Note : The resolver has a simple structure not using electronic components at all. It is highly resistant to low and high temperatures, impacts, electrical noise, dust particles, oil, etc. and is used in automobiles, trains, and airplanes.

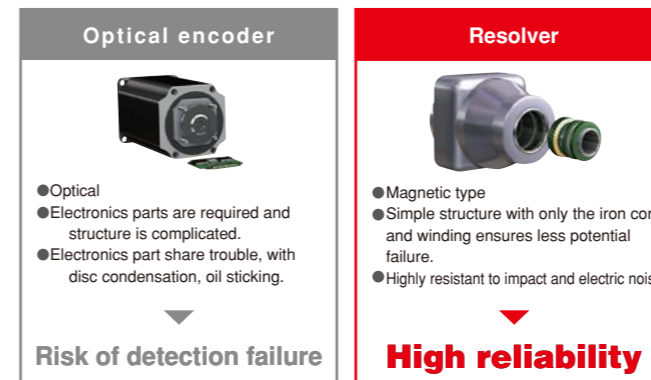

Superior rotary axis inertia moment capacity

SCARA robot performance is not limited to just standard cycle time. Actual work situations include a diverse range of heavy work pieces as well as work with large offsets. Using a low R axis inertia moment in those cases will help drastically cut the cycle time. All YAMAHA SCARA robots have a speed reducer directly coupled to the tip of the rotating axis. The R axis produces an extremely high allowable inertia moment which delivers high speed operation compared to structures where positioning is usually done by a belt after decelerating.



● R axis allowable inertia moment : Comparing YK120XG with competitor's models

Offset (mm)	Inertia (kgfcm ²)	Operation	
		YK120XG	A Corp.
0	0.0039	○	○
45	0.025	○	×
97	0.1	○	×

◆ R axis allowable inertia moment : YK120XG 0.1kgfcm²
A Corp. 0.0039kgfcm²

High speed

The standard cycle time is fast of course but the YAMAHA design also stresses cycle time in the actual usage region. A drastic improvement in maximum speed was made by changing the gear ratio and maximum motor rpm. This also resulted in a better cycle time during long distance movement.

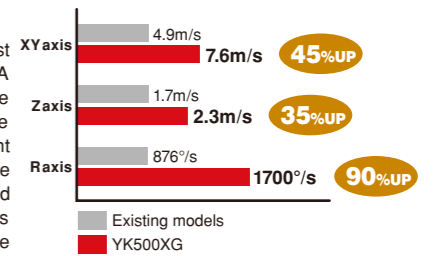

Hollow shaft and tool flange options are selectable

Useful options include a hollow shaft for easy wiring to the tip tool and a tool flange for tool clamping.

Note : YK250XG/YK350XG/YK400XG/YK500XGL/YK600XGL



Hollow shaft option for easy routing of air tubes and harness wires

Tool flange option for easy mounting of a tool to the tip

Improved maintenance features

The covers on the YAMAHA SCARA robot YK-XG series can be removed from the front or upwards. The cover is separate from the cable so maintenance tasks are easy.

On ordinary robots replacing the grease on the harmonic gear takes a great deal of time and trouble because the gear must be disassembled and position deviations might occur. On YAMAHA SCARA robots however the harmonic gear is the grease-sealed type so no grease replacement is needed (YK-500XG to YK1000XG).

Superior performance at low cost

Earlier models are provided at YAMAHA's lowest price without changing specifications.

Features of wall-mount / inverse type

Completely beltless structure ensures high rigidity.

As the conventional ceiling-mount type was changed to the wall-mount type, the flexibility of the system design is improved. This enables downsizing of the production equipment. Additionally, as the inverse type allowing upward operation is added to the lineup, the flexibility of the work direction becomes wide. Additionally, completely beltless structure achieves a maximum payload of 20kg and a R-axis allowable inertia moment of 1kgm²* that is the maximum level in this class. A large hand can also be installed. This robot is suitable for heavy load work.

Note : YK700XGS to YK1000XGS

Dust-proof and Drip-proof type

Bellows improved dust/drip proofing capability

The conventional robot was renewed to a dust-proof and drip-proof type completely beltless structure that can be used in a work environment where water droplets or dust particles scatter. Belt deterioration is eliminated and the robot is highly resistant to harsh environments. Additionally, using up/down bellows structure makes it possible to improve the dust-proof and drip-proof performance.

Note : YK250XGP to YK600XGLP

- Equivalent to protection grade IP65(IEC60529)
- Dust-proof and drip-proof connector for user wiring is available as a standard.

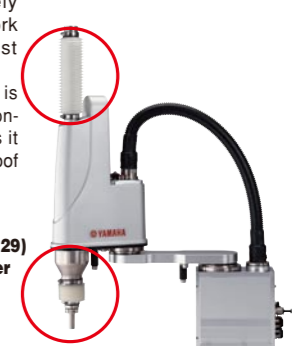

YK-TW Series

ORBIT TYPE SCARA ROBOT YK350TW
YK500TW



Quick selection table ▶▶ P20

Superior Positioning Accuracy and High Speed
Enables a smaller equipment footprint by eliminating the dead space at the center of the movement range.

YK-TW can move anywhere through the full $\phi 1000 \text{ mm}^2$ work envelope.

Featuring a ceiling-mount configuration with a wide arm rotation angle, the YK-TW can access any point within the full $\phi 1000 \text{ mm}$ downward range. This eliminates all motion-related restrictions with regard to pallet and conveyor placement operations, while dramatically reducing the equipment footprint.

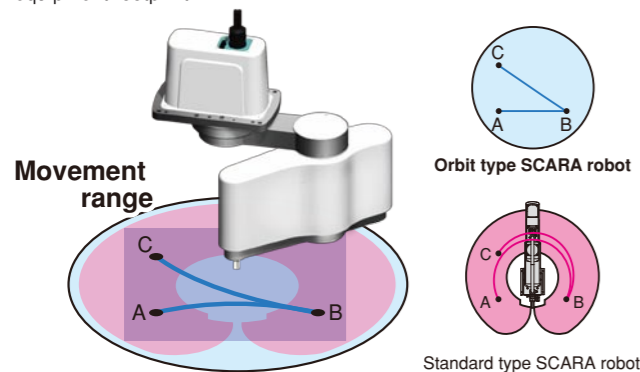

YK-TW offers a repeated positioning accuracy of $\pm 0.01 \text{ mm}^1$ (XY axes).

Higher repeated positioning accuracy than that of a parallel-link robot. This was accomplished by optimizing the robot's weight balance through an extensive re-design of its internal construction. The lightweight yet highly rigid arm has also been fitted with optimally tuned motors to enable high accuracy positioning.

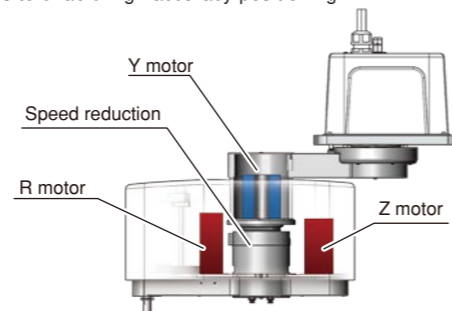

Hollow construction Y-motor and reduction gear feature a hollow construction which allows them to be housed inside the harness arm. 360° Rotation.	Optimized rotation center of gravity moment Weight balance was optimized by placing the R-motor and Z-motor at the left and right sides respectively. Reduced inertia enables high-speed motion.
--	--

Ideal for narrow space applications

Minimum installation width **492mm**

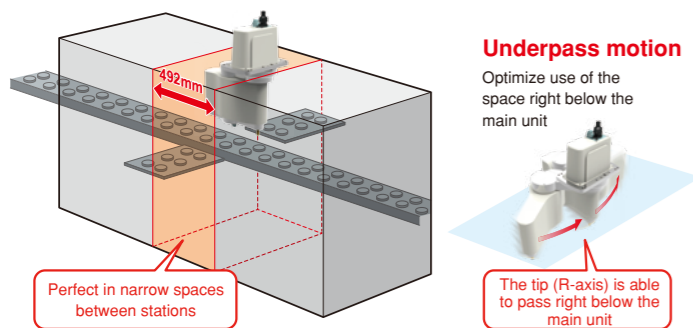

Standard cycle time of 0.29 secs.*2

Y-axis (arm 2) passes beneath the X-axis (arm 1) and it has a horizontal articulated structure, allowing it to move along the optimal path between points. Moreover, the optimized weight balance of the internal components reduces the cycle time by 36% as compared to previous models.

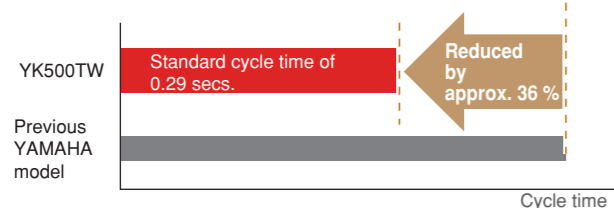

The standard cycle time for moving a 1-kg load horizontally 300 mm and up/down 25 mm is shortened by approximately 36% compared to existing YAMAHA models.

YK-TW offers both a lower profile and a smaller footprint.

YK-TW height is only 392 mm. This compact size enables more freedom in the equipment layout design.

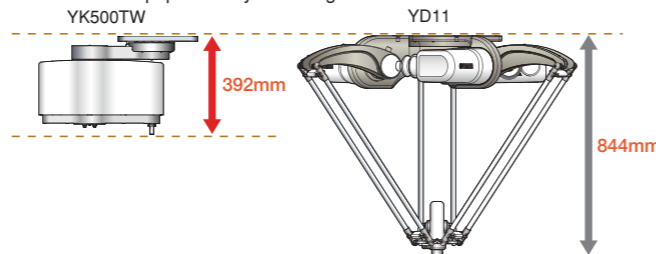

YK-TW has a total height of only 392 mm, and weighs only 27 kg*2.
Lower inertia = Lighter frame



An optional dedicated installation frame is available for the YK-TW. For details, contact a YAMAHA sales representative.

*1. Applies to the YK350TW *2. Applies to the YK500TW

CLEAN ROOM Type

CLEAN ROBOTS



Quick selection table ▶▶ P20-21

Class 10 rating sealed structure reduces particle generation, and air-intake efficiency improvement to establish both high cleanliness and high performance.

YK-XGC/XC Clean room SCARA robots

- Arm length : 180mm to 1000mm
- Intake air : 30 to 60N /min
- Degree of cleanliness : CLASS ISO3 (ISO14644-1) CLASS10 (FED-STD-209D)
- Maximum payload : 20kg



The Z-axis spline is covered with bellows made of materials with lower dust emission and other sliding parts are sealed completely. The harness is also completely built-in and the suction inside the robot is performed from the rear of the base to prevent dust emission.

Bellows on vertical axis improves reliability of the clean performance.

Completely beltless structure improves rigidity.

FLIP-XC Clean room Single-axis robots

- Stroke : 50 to 2050mm
- Intake air : 15 to 90N /min
- Cleanliness rating : CLASS 10^{Note}
- Maximum payload : 120kg (Horizontal installation)

Note : C4L/C4LH, C5L/C5LH, and C6L conform to CLASS ISO3 (ISO14644-1).



Clean room specifications of "FLIP-X series". An appropriate model suitable for the application can be selected from 14 models ranging from lightweight and compact model to large model with a maximum payload of 120 kg. A suction air joint is available as a standard, low dust emission grease is used, and stainless steel sheet with excellent durability is mounted on the slide table surface to achieve high cleanliness.

SSC Clean room Single-axis robots (TRANSERVO)

- Stroke : 50 to 800mm
- Intake air : 15 to 80N /min
- Cleanliness rating : CLASS 10
- Maximum payload : 12kg (Horizontal installation)



Clean room specifications of "TRANSERVO series". Use of a newly developed vector control system with adoption of stepping motor makes it possible to achieve the functions and performances similar to the servomotor at a low cost. A suction air joint is available as a standard, low dust emission grease is used, and stainless steel sheet with excellent durability is mounted on the slide table surface to achieve high cleanliness.

Improved maintenance features

XY-XC Clean room cartesian robots

- Intake air : 60 to 90N /min
- Cleanliness rating : CLASS 10^{Note}
- Maximum payload : 20kg
- Maximum speed : 1000mm/sec

Note : User cable D-Sub 25 pin connector 24 conductors, 0.3 sq
Note : User tube three 6 air tubes.

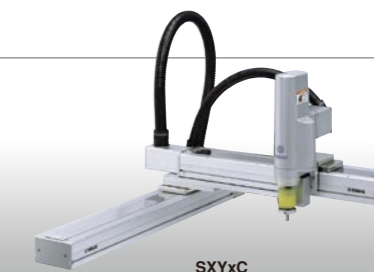

Clean room applicable type of "Cartesian robot". Use of stainless steel sheets with excellent durability makes it possible to design the opening at its minimum level. The robot is applicable to CLASS10 with less suction amount. Furthermore, as a super-high speed unit of the SCARA robot is used for the ZR-axis of SXYxC, the cycle time is greatly shortened.

CONTROLLERS

CONTROLLERS



iVY System

ROBOT VISION FOR THE RCX240

Wide range of control systems to choose from.
From single axis positioner to multi-axis comprehensive absolute controller covering DC Stepping Motor, AC Servo Motor, and Linear Motor.

	TRANSERVO Stepping motor	FLIP-X [T4L/T5L] Small servo (24V · 30W)	General-purpose servo (30 to 600W)	PHASER Linear motor
1 axis	<ul style="list-style-type: none"> I/O point trace Remote command 			
	<ul style="list-style-type: none"> Program (YAMAHA SRC language) I/O point trace Remote command Online instructions 			
2 axes				
3, 4 axes				
5 to 8 axes	YC-Link YC-LINK couples single-axis controllers to a 4-axis controller Note : Up to four SR1 series controllers can be connected to the RCX series controller.			
up to 16 axes	YC-Link/E Up to four RCX340 controllers (up to 16 controllable axes) can be connected.			

P Robot positioner

Simple operation only by specifying point number data
The TS series are robot positioners that operate just by specifying a point No. and entering a START signal. These can do positioning or push operations without having to write a program. Speed changes can be made during movement by carrying out linked operation.

D Robot driver

Pulse train input driver for single-axis robot
As the operation with the robot language is omitted and the driver is dedicated to the pulse train input, the driver can be easily built into the automatic machine unit as a compact control unit.

C Robot controllers



Diverse command methods
Select an optimal method from the different command methods including program operation, point trace, remote command, and on-line command. Program uses the YAMAHA SRC language resembling BASIC. Use it to execute a variety of operations ranging from simple tasks to I/O output and conditional branching, etc.

Powerful support software

The low-cost and high-performance TS-Manager was newly developed for the TS series. This single software performs all operations such as point data settings, editing, backup and teaching tasks. It also comes loaded with real-time trace functions such as current values, speed, load factors, current values, and voltage values.



Simple "plug-and-play" set up with conveyor tracking features in one

iVY system layout

Gives you a ready-to-go robot controller equipped with an image processing function by just setting an iVY board in your 4-axis robot controller RCX240 or RCX240S. Putting "eyes" in your robot allows you to search and take workpieces, find deviations in workpiece position and make corrections even in the case of large errors, expanding the range of applications.

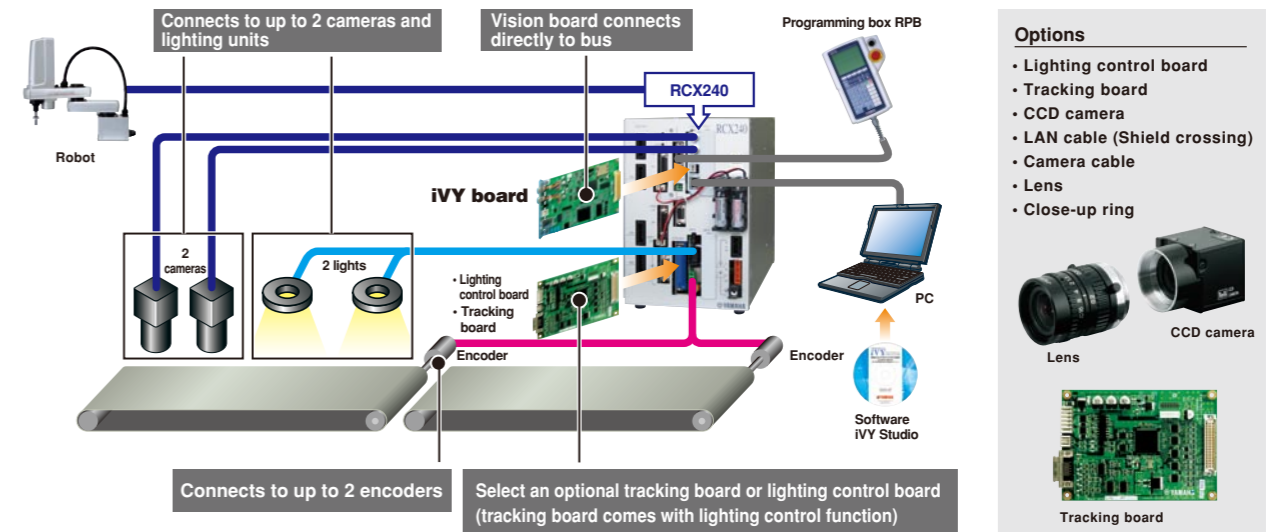

Seamlessly integrated vision system in robot controller

Other machine vision products on the market use different formats, so a coordinate conversion program had to be written into the controller. The iVY system has an integrated controller so robot point data is stored in one easy step. Camera control and lighting control are handled by an integrated operation within the robot controller with an easy to understand operation that reduces the man-hours needed for equipment startup.

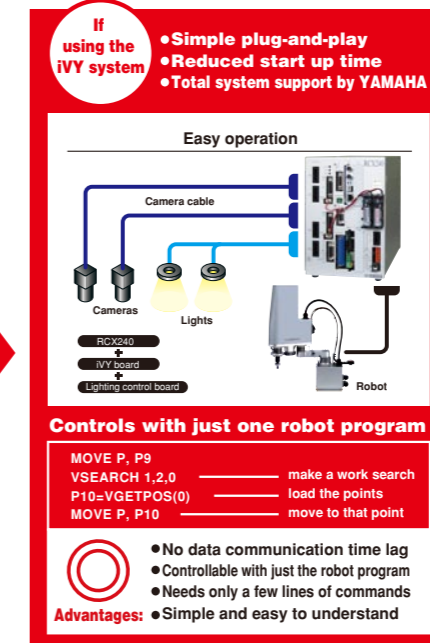
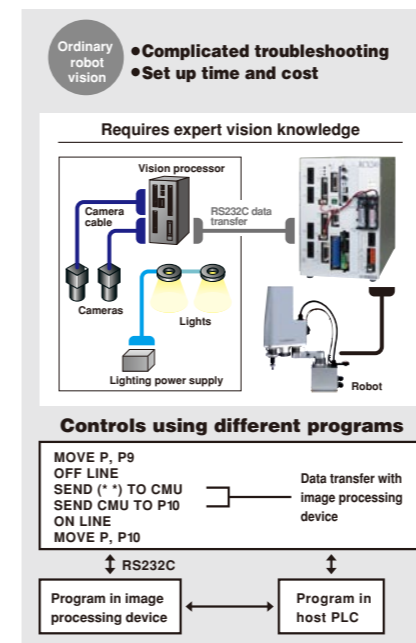

Super simple calibration (Coordinate matching alignment tasks)

Conventional equipment combining "image processing equipment + robot" requires an extreme amount of time and trouble due to the task of "calibration" that aligns the camera coordinates with the robot coordinates. On the iVY system however the operator only has to follow conversation-type instructions from the programming box so operation is simple and finishes in a short time. The iVY system also automatically corrects these coordinates even if the robot installation position has changed during tasks such as clamping upward, clamping downward, clamping robot Z axis, and clamping the Scara robot Y arm.

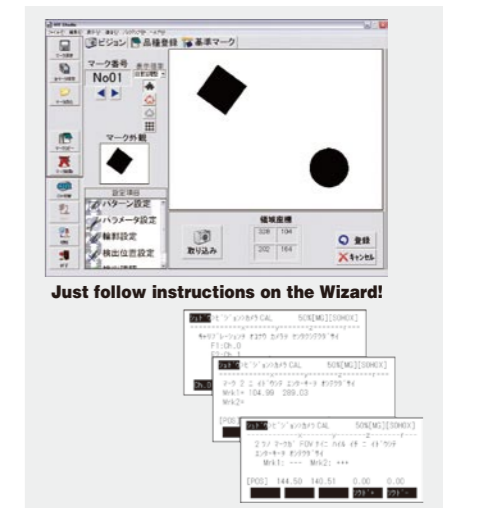

iVY2 System

ROBOT VISION
FOR THE RCX340



YRG Series

ELECTRIC GRIPPER

Quick selection table ▶▶ P20



A robot-integrated vision system means simplicity, high functionality, and reliability.
Ease of original iVY, with greatly improved performance.

Supporting five-megapixel cameras*

(Choose from 300,000 pixel, 1.3 megapixel, 2 megapixel and 5 megapixel)

Detailed edge detection is possible even if workpieces are touching each other or have a complex shape. A single search allows detection even for a large workpiece, improving takt.

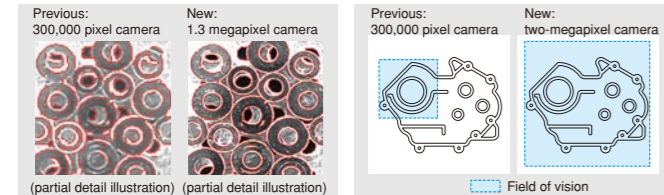

* 5-megapixel camera: Support is expected in March 2016

Approximately double the search speed (compared to previous model)

The search speed is approximately double that of the previous model. Even a large number of workpieces can be detected at high speed. This can be used for a wide variety of applications, including molded plastic parts or food items.

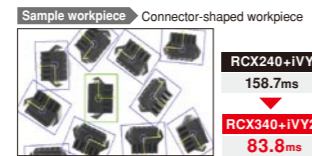

254 types can be registered

Setup changes require only that part numbers be changed.

254 types (0 to 253) can be registered

With monitor output

Monitor the search status while making calibration settings or during automatic operation.



System configuration illustration iVY2

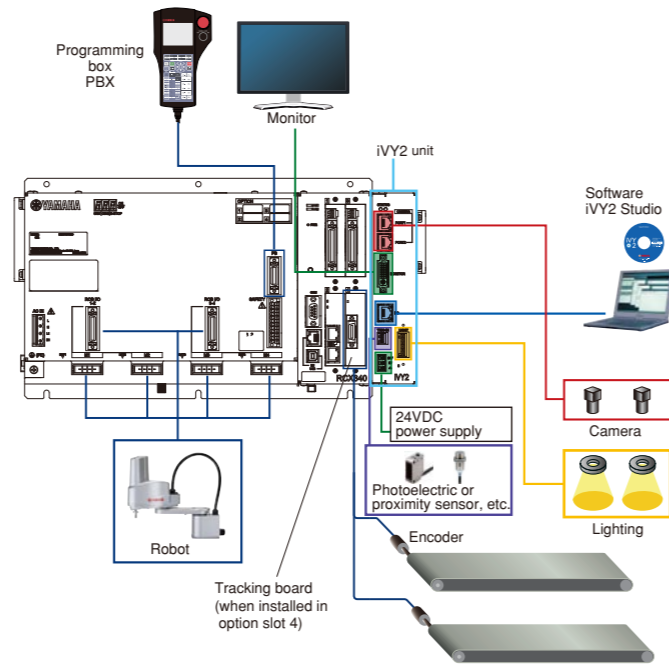

* The illustration above shows an example system with the tracking board and an iVY2 unit (when the lighting control board option is selected).
* Connections to the STD.DIO, ACIN, and SAFETY connectors are not shown in the above illustration.

Control multiple robots for additional increase in productivity.

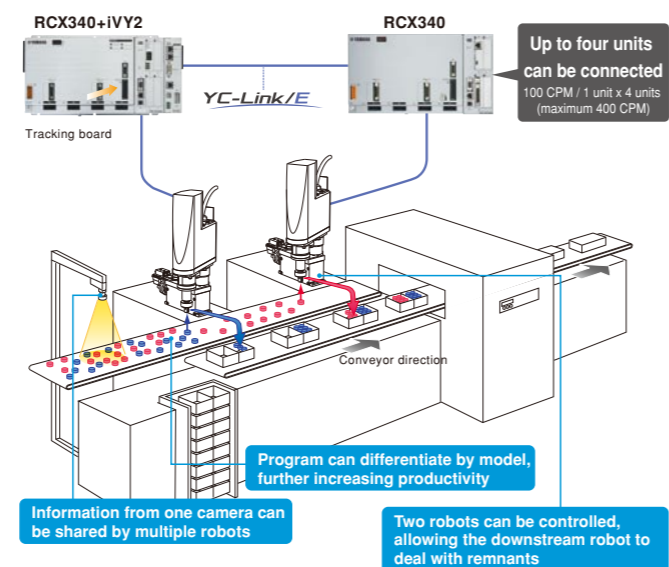

Conveyor tracking capability up to 100 CPM.

The vision camera detects the position and orientation of parts on moving conveyor for pick & place application.

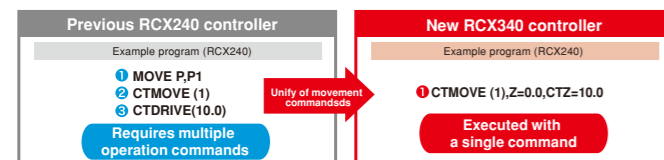

Move-up command, track workpiece command, and move-down command, in one.

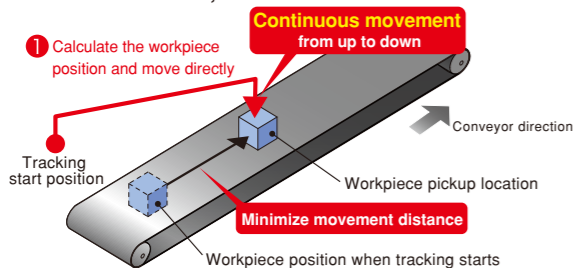

Operating conditions: YK500XG / Payload mass 1 kg (total of tool and workpiece) / Horizontal movement 250 mm / Vertical movement 1 mm / Conveyor speed 100 mm/sec

Easy operation by YAMAHA's robot language.

Gripping power control Adjustable in 1% increment from 30 to 100%.	Measuring Measures a workpiece by position detection.	Speed control Adjustable in 1% increment from 20 to 100% for speed and 1 to 100% for acceleration.	Multi-point Control Up to 10,000 points	Workpiece check function Utilizes the HOLD output signal to check if the gripper fails to grip a workpiece or drops it, without using a sensor.
--	---	--	---	---

S type Single cam type

Lightweight, compact, high-speed



W type Double cam type

High gripping force



Screw type

Straight style
High precision, long stroke



"T" style



Three fingers type

Compact, high rigidity, long stroke



Electric gripper for high-precision gripping force, positioning, and speed control

YRG delivers gripping power control, speed and acceleration control, multi-point positioning, and measuring of workpieces, which have been difficult for air-driven devices. The YRG proves a flexible fit for a wide range of applications.

Gripping force control

The gripping force can be set in 1% increments. A fragile or deformable workpiece, such as glass or spring can also be gripped. The gripping force is constant even when the finger position is changed.

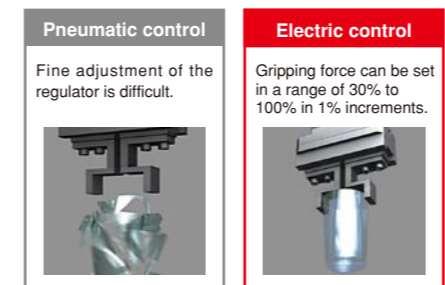

Multi-point Control

The finger position can be set to a desired position corresponding to the workpiece size. This contributes to efficiency improvement of the line with workpiece size and material mixed or the line needing frequent setup.

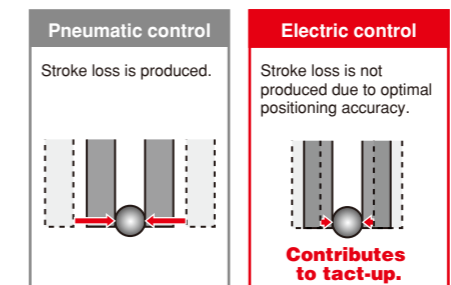

Workpiece presence check function

The electric gripper outputs the HOLD signal. Missing workpiece gripping and workpiece drop during transfer can be checked. No external sensor is needed.

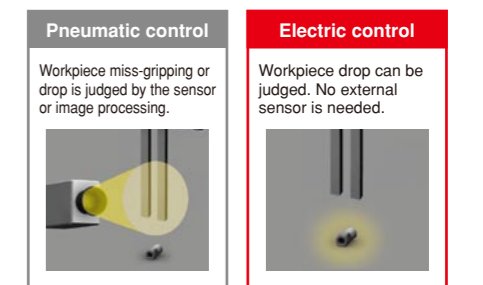

Controllable with a single controller

The gripper can be controlled with a single controller. Since there's no need for interchange with a PLC or other host device, setup and startup is dramatically simpler.

Combination with a vision system supports a wide range of applications

As the YRG series is combined with controller integrated robot vision "iVY2 System", the operations from the positioning using the camera to workpiece handling can be controlled in the batch mode using the RCX340 controller. Sophisticated systems can be easily configured.

* Can also be used with the RCX240 controller

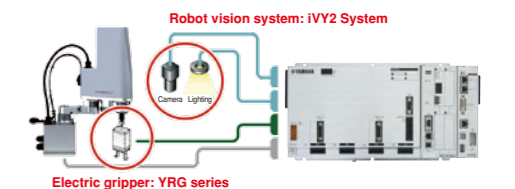

LCM100

LINEAR CONVEYOR MODULES

Basic specifications ▶▶ P22



From "simple flow" to "controlled move"
Construct a rapid-throughput line for increased profitability.



Module system for easy line layout change

A transfer line is configured by connecting the number of necessary modules as required. Of course, new line configuration and line change can be started up speedily. Additionally, operations, such as shortening of the line, diversion of excess modules to other line, and storing of excess modules for the maintenance work can be performed.

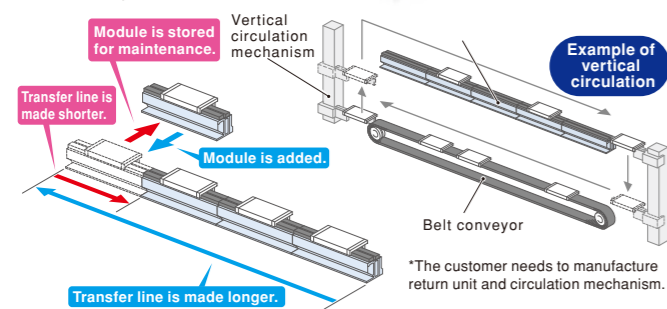

High-speed movement and smooth deceleration stop using servo control prevent mechanical stopper collision.

Smooth deceleration stop by servo control. Since workpiece deviation by stopper collision or damage is eliminated, the highspeed movement is possible.

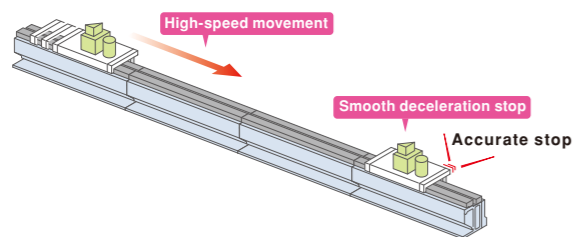

Freedom in line configuration using flexible slider movement.

LCM100 can freely change the forward movement, backward movement, acceleration, and deceleration. As flexible operations, such as stopping at necessary location correctly, speed change, or moving only some sliders backward can be made, the line can be designed with a higher flexibility. Since the movement direction can be changed, the same processes are made common. Cost reduction and compact equipment are achieved.

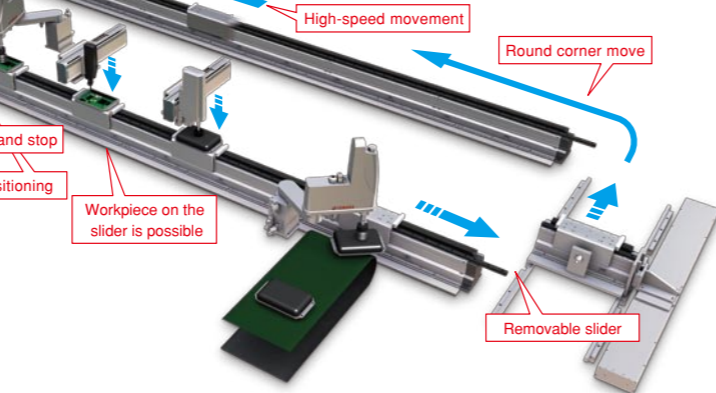
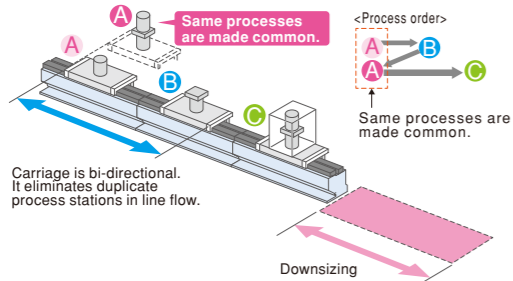

Efficient move between tasks in line

- Narrow pitch movement is possible.
- Movement time can be reduced by combining the use of different movements, such as using pitch-feed for the same processes in short-time processes while transferring three workpieces at the same time at a high speed in long-time processes.

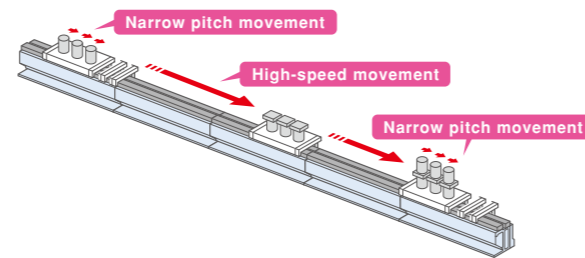

Performing tasks directly on the conveyor

- Reduces operation time and work space = \$\$.

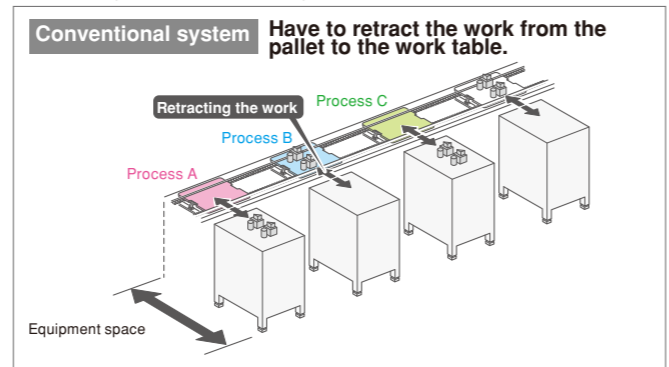

LCM100 Work space can be eliminated a work table

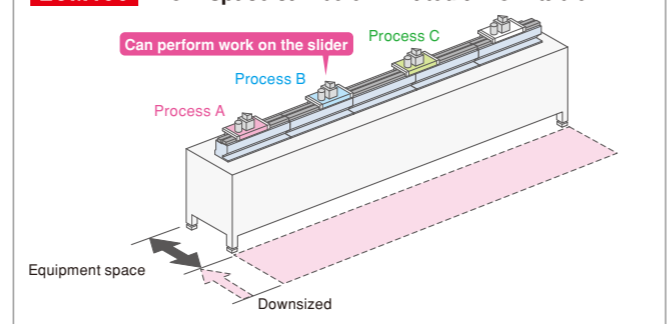

YA Series

VERTICALLY ARTICULATED ROBOTS

6-axis 7-axis

Quick selection table ▶▶ P22



Increase productivity Ideal for constructing compact cells, moving and assembling small parts, or inspection processes.

6-axis



7-axis

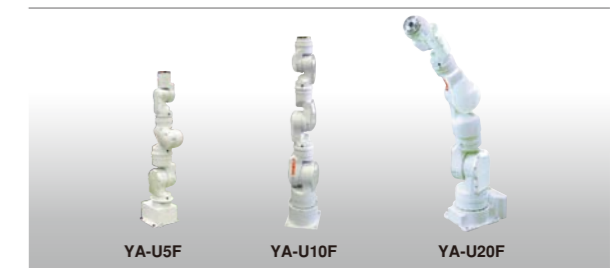

High-speed operation reduces cycle time

Thanks to high-speed, low-inertia AC servo motors, an arm designed for light weight, and the latest control technology, these robots achieve an operating speed that is best in their class. From supply, assembly, inspection, and packing to palletization, all applications can enjoy shorter cycle time and improved productivity.

Workpieces with a high wrist load are also supported

With a wrist section that has the highest allowable moment of inertia in its class, these robots can support jobs involving a high wrist load, or simultaneous handling of multiple workpieces.

Dramatically reduce line setup time with a simulator

We provide software that lets you use 3D CAD data to construct a production facility in virtual space in a personal computer, and easily perform engineering tasks such as creating programs and checking for robot interference. Teaching can be performed even before the actual production line is completed, dramatically reducing line startup time. * Optional support



7-axis

Reduced space allows sophisticated system layouts

Since these robots can be installed close to workpieces or other equipment, you can reduce the space required for your production facility. By locating multiple robots close to each other, processing can be integrated and shortened.

7-axis

Access the workpiece from the opposite side or from below

Rotation of the seventh axis enables flexible movement with the same freedom of motion as a human arm, allowing the workpiece to be accessed from the opposite side or from below. This allows the robot to enter narrow locations that a person could not fit in, or to approach the workpiece in a way that avoids obstructions, giving you more freedom to design the layout for shorter cycle time and reduced space.

7-axis

"Elbow movement" unique to 7-axis models allows optimal posture to be maintained

The 7-axis U-type robots allow "elbow movement," changing only the elbow angle without affecting the position or posture of the tool. This permits operation to avoid nearby obstructions.

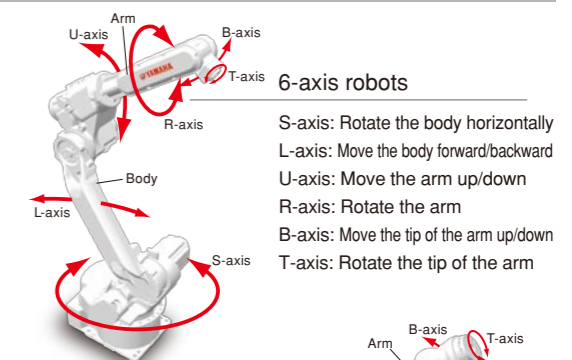
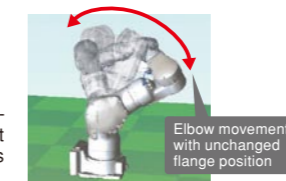

Free arm movement further boosts productivity.

7-axis robots

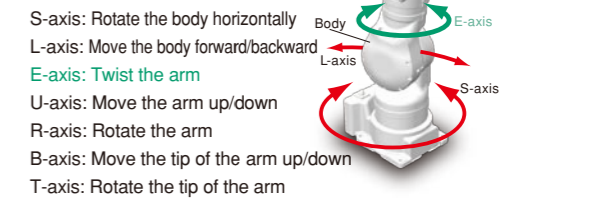

Controller Specifications YAC100



YAC100 Controller Specifications	
Configuration	Standard: IP20 (open structure), Option: IP54 (dustproof housing)
Dimensions	470 (W)x420 (D)x200 (H) mm (Protrusions are not included.)
Mass	20 kg
Cooling System	Direct cooling
Ambient Temperature	During operation: 0°C to +40°C. During storage: -10°C to +60°C
Relative Humidity	90% max. (non-condensing)
Power Supply *	Single-phase 200/230 VAC (+10% to -15%), 50/60 Hz Three-phase 200/220 VAC (+10% to -15%), 50/60 Hz
Grounding	Grounding resistance: 100 Ω or less
Digital I/Os	Specialized signals: 10 inputs and 1 output General signals: 28 inputs and 28 outputs Max. I/O (optional): 1,024 inputs and 1,024 outputs
Positioning System	By serial encoder
Programming Capacity	JCB: 10,000 steps, 1,000 instructions C/O ladder: 1,500 steps
Expansion Slots	1 (10BASE-T/100BASE-TX)
LAN (Connection to Host)	RS-232C: 1ch
Interface	Software servo control
Control Method	Six axes for robots. Two more axes can be added as external axes. (Can be installed in the controller.)
Drive Units	Munsell notation 5Y7/1 (reference value)
Painting Color	Munsell notation 5Y7/1 (reference value)

* YA-R6F: Three-phase only.

TRANSERVO CLOSED LOOP STEPPING MOTOR SINGLE-AXIS ROBOTS

Type	Size (mm) ^{Note 1}	Model	Lead (mm)	Maximum payload(kg) ^{Note 2}		Maximum speed (mm/sec) ^{Note 3}	Stroke (mm)
				Horizontal	Vertical		
					SR		
SS type (Slide type) Inline model / Foldback model	W49 x H59	SS04-S SS04-R(L)	12	2	1	600	50 to 400
			6	4	2	300	
			2	6	4	100	
	W55 x H56	SS05-S SS05-R(L)	20	4	-	1000	50 to 800
			12	6	1	600	
			6	10	2	300	
	W55 x H56	SS05H-S SS05H-R(L)	20	6	-	1000	50 to 800
			12	8	2	600 (Horizontal) 500 (Vertical)	
			6	12	4	300 (Horizontal) 250 (Vertical)	
SG type (Slide type)	W65 x H64	SG07	20	36	4	1200	50 to 800
			12	43	12	800	
			6	46	20	350	
SR type (Rod type standard) Inline model / Foldback model	W48 x H56.5	SR03-S SR03-R(L) SR03-U	12	10	4	500	50 to 200
			6	20	8	250	
			12	25	5	500	
	W48 x H58	SR04-S SRD04-R(L)	6	40	12	250	50 to 300
			2	45	25	80	
			12	50	10	300	
	W56.4 x H71	SR05-S SRD05-R(L)	6	55	20	150	50 to 300
			2	60	30	50	
			12	10	3.5	500	
SR type (Rod type with support guide) Inline model / Foldback model	W105 x H56.5	SRD03-S SRD03-U	6	20	7.5	250	50 to 200
			12	25	4	500	
			6	40	11	250	
	W135 x H58	SRD04-S SRD04-U	2	45	24	80	50 to 300
			12	50	8.5	300	
			6	55	18.5	150	
	W157 x H71	SRD05-S SRD05-U	2	60	28.5	50	50 to 300
			12	10	3.5	500	
			6	20	7.5	250	
STH type (Slide type) Inline model/ Foldback model	W45 x H46	STH04-S	5	6	2	200	50 to 100
	W73 x H51	STH04-R(L) ^{Note 4}	10	4	1	400	
	W61 x H65	STH06	8	9	2	150	50 to 150
	W106 x H70	STH06-R(L)	16	6	4	400	

Note 1. Size is the approximate cross sectional size. Note 2. Maximum speed varies with the payload. See the SR type page for more details.
 Note 3. Maximum speed decreases due to ball screw critical speed when the stroke is long. See the SR type page for more details. Note 4. STH04-R (L) with 50st brake is not available.
 ■ Allowable ambient temperature for robot installation SS/SR type: 0 to 40°C STH/RF/BD type: 5 to 40°C

PHASER LINEAR MOTOR SINGLE-AXIS ROBOTS

Type	Size (mm) ^{Note 1}	Model	Carriage	Maximum payload(kg)		Maximum speed (mm/sec)	Stroke (mm)
				Horizontal	Vertical		
MF type Steel cored linear motor with falt magnet	W85 x H80	MF7	Single	10 (7) ^{Note 2}	-	2500	100 to 4000(Horizontal) 100 to 2000(Wall mount)
			Double				100 to 3800(Horizontal) 100 to 1800(Wall mount)
	W100 x H80	MF15	Single	30 (15) ^{Note 2}	-	2500	100 to 4000(Horizontal) 100 to 2000(Wall mount)
			Double				100 to 3800(Horizontal) 100 to 1800(Wall mount)
	W150 x H80	MF20	Single	40 (20) ^{Note 2}	-	2500	150 to 4050
			Double				150 to 3850
			Single				100 to 4000
	W210 x H100	MF30	Single	60 (30) ^{Note 2}	-	2500	150 to 3750
			Double				1000 to 4000
	W210 x H100	MF75	Single	160 (75) ^{Note 2}	-	2500	680 to 3680
			Double				50 to 1050
	MF type Shaft type linear	W60 x H90	MR12	Single	5	-	2500
Double				50 to 1050			

Note 1. Size is the approximate cross sectional size. Note 2. If using at maximum speed then the payload will be as shown in the ().

XY-X CARTESIAN ROBOTS

Model	Arm variations					Number of axes	Maximum payload (kg)	Maximum stroke (mm)	
	Arm	Gantry	Moving arm	Pole	XZ			X axis	Y axis
PXYx	●	-	-	-	-	2 axes	4.5	150 to 650	50 to 300
FXyX	●	-	-	-	-	2 axes / 3 axes	12	150 to 1050	150 to 550
FXyBx	●	-	-	-	-	2 axes	7	150 to 2450	150 to 550
SXYx	●	-	●	●	●	2 axes / 3 axes / 4 axes	20	150 to 1050	150 to 650
SXYBx	●	-	-	-	●	2 axes / 3 axes / 4 axes	14	150 to 3050	150 to 550
MXyX	●	●	●	●	●	2 axes / 3 axes / 4 axes	30	250 to 1250	150 to 650
NXY	●	-	-	-	-	2 axes / 3 axes	25	500 to 2000	150 to 650
NXY-W	●	-	-	-	-	4 axes / 6 axes	25	250 to 1750	150 to 650
HXYx	●	●	●	●	●	2 axes / 3 axes / 4 axes	40	250 to 1250	250 to 650
HXYLx	●	●	-	-	-	2 axes	40	1150 to 2050	250 to 650

Note. The above maximum payloads are maximum stroke lengths are values when using arm type/cable carrier specifications.

FLIP-X SINGLE-AXIS ROBOTS

Type	Size (mm) ^{Note 1}	Model	Lead (mm)	Maximum payload (kg)		Maximum speed (mm/sec)	Stroke (mm)
				Horizontal	Vertical		
T type Compact model	W45 x H53	T4L/T4LH	12	4.5	1.2	720	50 to 400
			6	6	2.4	360	
			2	6	7.2	120	
	W55 x H52	T5L/T5LH	20	3	-	1200	50 to 800
			12	5	1.2	800	
			6	9	2.4	400	
	W65 x H56	T6L	20	10	-	1333	50 to 800
			12	12	4	800	
			6	30	8	400	
	W94 x H98	T9 (Standard)	30	15	-	1800	150 to 1050
			20	30	4	1200	
			10	55	10	600	
5			80	20	300		
30			25	-	1800		
20			40	8	1200		
T9H (High thrust)		10	80	20	600	150 to 1050	
		5	100	30	300		
		20	12	-	1200		
F type High rigidity model	W80 x H65	F8	12	20	4	720	150 to 800
			6	40	8	360	
			30	7	-	1800	
	W80 x H65	F8L	20	20	4	1200	150 to 1050
			10	40	8	600	
			5	50	16	300	
	W80 x H65	F8LH	20	30	-	1200	150 to 1050
			10	60	-	600	
			5	80	-	300	
			30	15	-	1800	
			20	20	4	1200	
			10	40	10	600	
W110 x H71		F10	5	60	20	300	150 to 1050
			30	25	-	1800	
			20	40	8	1200	
W136 x H83	F10H (High thrust)	10	80	20	600	150 to 1000	
		5	100	30	300		
		30	15	-	1800		
		20	30	4	1200		
		10	55	10	600		
		5	80	20	300		
	F14 (Standard)	30	25	-	1800	150 to 1050	
		20	40	8	1200		
		10	80	20	600		
F14H (High thrust)	5	100	30	300	150 to 1050		
	30	15	-	1800			
	20	30	4	1200			
W168 x H100	F17	10	55	10	600	150 to 1050	
		5	80	20	300		
		30	25	-	1800		
W202 x H115	F20	20	40	8	1200	150 to 1050	
		10	80	20	600		
		5	100	30	300		
W202 x H120	F20N	20	80	-	1200	1150 to 2050	
		10	120	35	600		
		40	60	-	2400		
GF type High rigidity model	W145 x H91.5	GF14XL	20	45	-	1200	750 to 2000
			10	90	-	1200	
			5	180	-	1200	
N type Nut rotation model	W145 x H120	N15 (Single carriage) N15D (Double carriage) N18 (Single carriage) N18D (Double carriage)	20	50	-	1200	500 to 2000 250 to 1750 500 to 2500 250 to 2250
			10	100	-	1200	500 to 2000 250 to 1750 500 to 2500 250 to 2250
			5	200	-	1200	500 to 2000 250 to 1750 500 to 2500 250 to 2250
B type Timing belt drive model	W100 x H81	B10 B14(Standard) B14H(High thrust)	Belt drive	10	-	1875	150 to 2550
			Belt drive	20	-	1875	150 to 3050
			Belt drive	30	-	1875	150 to 3050
R type Rotation axis model	-	-	R5	0.12kgm ²	-	360°/sec	360°
			R10	0.36kgm ²	-		
			R20	1.83kgm ²	-		

Note 1. Size is the approximate cross sectional size.

YK-XG/YK-XR/YK-TW/YK-XGS/YK-XGP SCARA ROBOTS

Type	Model	Arm length (mm)	Maximum payload (kg)	Standard cycle time (sec) ^{Note 1}			
Standard	Tiny type	YK120XG	120	1.0	0.33		
		YK150XG	150				
		YK180XG	180				
		YK180X	180				
		YK220X	220				
		YK250XG	250				
	Small type	YK350XG	350	5.0	0.49		
		YK400XG	400				
		YK400XR	400				
		YK500XGL	500				
		YK500XG	500				
		YK600XGL	600				
	Medium type	YK600XG	600	10.0(9.0) ^{Note 2}	0.45		
		YK600XGH	600				
		YK700XGL	700				
		YK700XG	700				
		YK800XG	800				
		YK900XG	900				
Large type	YK1000XG	1000	20.0	0.42			
	YK1200X	1200					
	YK300XGS	300			5.0 ^{Note 2}	0.49	
	YK400XGS	400					
	YK500XGS	500					
	YK600XGS	600					
YK700XGS	700						
Wall-mount / inverse type	YK800XGS	800	10.0	0.46			
	YK900XGS	900					
	YK1000XGS	1000					
	YK250XGP	250			20.0	0.42	
	YK350XGP	350					
	YK400XGP	400					
	YK500XGLP	500					
	YK500XGP	500					
	YK600XGLP	600					
	Dust-proof & drip-proof type	YK600XGP	600	18.0	0.48		
		YK600XGHP	600				
		YK700XGP	700				
YK800XGP		800					
YK900XGP		900					
YK1000XGP		1000					
Orbit type		YK350TW	350	5.0(4.0) ^{Note 3}	0.49		
		YK500TW	500				
		YK350XG	350			18.0	0.52
		YK400XG	400				
YK500XG		500					
YK600XG		600					

Note 1. Ultra-small type: Maximum payload: 0.1kg (100mm in the horizontal direction, 25mm-reciprocating in the vertical direction, coarse positioning) Orbit type: Maximum payload: 1kg (300mm in the horizontal direction, 25mm-reciprocating in the reciprocating direction, coarse positioning) Other type: Maximum payload: 2kg (300mm in the horizontal direction, 25mm-reciprocating in the reciprocating direction, coarse positioning)
 Note 2. Maximum payload of option specifications (with tool flange attached or with user wiring and tubing routed through spline shaft) is 4kg. Note 3. Values in parentheses () apply for tool flange specifications.

YRG ELECTRIC GRIPPER

Type	Model	Holding power (N)	Open/close stroke (mm)	Maximum speed (mm/sec)	Repeatability (mm)	Weight (g)
Compact single cam	YRG-2005SS	5	3.2	100	±0.02	90
	YRG-2010S	6	7.6	100	±0.02	160
Single cam	YRG-2815S	22	14.3	100	±0.02	300
	YRG-4225S	40	23.5	100	±0.02	580
Double cam	YRG-2005W	50	5	60	±0.03	200
	YRG-2810W	150	10	60	±0.03	350
	YRG-4220W	250	19.3	45	±0.03	800
Screw type Straight style	YRG-2020FS	50	19	50	±0.01	420
	YRG-2840FS	150	38	50	±0.01	880
Screw type "T" style	YRG-2020FT	50	19	50	±0.01	420
	YRG-2840FT	150	38	50	±0.01	890
Three fingers	YRG-2004T	2.5	3.5	100	±0.03	90
	YRG-2013T	2	13	100	±0.03	190
	YRG-2820T	10	20	100	±0.03	340
	YRG-4230T	20	30	100	±0.03	640

● Holding power control: 30 to 100% (1% steps) ● Speed control: 20 to 100% (1% steps) ● Acceleration control: 1 to 100% (1% steps)
 ● Multipoint position control: 10,000 max. ● Workpiece size judgment: 0.01 mm units (by ZON signal)

CLEAN ROOM SCARA ROBOTS

Type	Model	Arm length (mm)	Maximum payload (kg)	Standard cycle time (sec) ^{Note}	Beltless structure
Tiny type	YK180XC	180	1	0.42	○
	YK220XC	220	1	0.45	○
Small type	YK250XGC	250	4	0.57	○
	YK350XGC	350	4	0.57	○
	YK400XGC	400	4	0.57	○
Medium type	YK500XC	500	10	0.53	-
	YK500XGLC	500	4	0.74	○
	YK600XC	600	10	0.56	-
	YK600XGLC	600	4	0.74	○
	YK700XC	700	20	0.57	-
	YK800XC	800	20	0.57	-
	YK1000XC	1000	20	0.60	-

Note. Ultra-small type: Maximum payload: 0.1kg (100mm in the horizontal direction, 25mm-reciprocating in the vertical direction, coarse positioning)
 Other type: Maximum payload: 2kg (300mm in the horizontal direction, 25mm-reciprocating in the reciprocating direction, coarse positioning)

CLEAN ROOM SINGLE-AXIS ROBOTS

Type	Model	Size (mm) ^{Note}	Lead (mm)	Maximum payload (kg)		Maximum speed (mm/sec)	Stroke (mm)
				Horizontal	Vertical		
FLIP-XC type	C4L C4LH	W45xH55	12	4.5	1.2	720	50 to 400
			6	6	2.4	360	
			2	6	7.2	120	
	C5L C5LH	W55xH65	20	3	-	1000	50 to 800
			12	5	1.2	800	
			6	9	2.4	400	
	C6L	W65xH65	20	10	-	1000	50 to 800
			12	12	4	800	
			6	30	8	400	
	C8	W80xH75	20	12	-	1000	150 to 800
			12	20	4	720	
			6	40	8	360	
	C8L	W80xH75	20	20	4	1000	150 to 1050
			10	40	8	600	
			5	50	16	300	
	C8LH	W80xH75	20	30	-	1000	150 to 1050
			10	60	-	600	
			5	80	-	300	
	C10	W104xH85	20	20	4	1000	150 to 1050
			10	40	10	500	
5			60	20	250		
C14	W136xH96	20	30	4	1000	150 to 1050	
		10	55	10	500		
		5	80	20	250		
C14H	W136xH96	20	40	8	1000	150 to 1050	
		10	80	20	500		
		5	100	30	250		
C17	W168xH114	20	80	15	1000	250 to 1250	
		10	120	35	600		
C17L	W168xH114	50	50	10	1000	1150 to 2050	
		20	120	25	1000		
C20	W202xH117	10	-	45	500	250 to 1250	
		12	2	1	600		
SSC type (TRANSERVO)	SSC04	W49xH59	6	4	2	300	50 to 400
			2	6	4	100	
			20	4	-	1000	
	SSC05	W55xH56	12	6	1	600	50 to 800
			6	10	2	300	
			20	6	-	1000	
	SSC05H	W55xH56	12	8	2	600(Horizontal)/ 500(Vertical)	50 to 800
			6	12	4	300(Horizontal)/ 250(Vertical)	
			20	6	-	1000	

Note. Size is the approximate cross sectional size.

CLEAN ROOM CARTESIAN ROBOTS

Type	Model	Axes	Moving range (mm)	Maximum speed (mm/sec)	Maximum payload (kg)
2 axes	SXYxC	X	150 to 1050mm	1000	20
		Y	150 to 650mm	1000	
3 axes	SXYxC (ZSC12)	X	150 to 1050mm	1000	3
		Y	150 to 650mm	1000	
		Z	150mm	1000	
3 axes	SXYxC (ZSC6)	X	150 to 1050mm	1000	5
		Y	150 to 650mm	1000	
		Z	150mm	500	
4 axes	SXYxC (ZRSC12)	X	150 to 1050mm	1000	3
		Y	150 to 650mm	1000	
		Z	150mm	1000	
	SXYxC (ZRSC6)	R	360°	1020°/sec	5
		X	150 to 1050mm	1000	
		Y	150 to 650mm	1000	
		Z	150mm	500	
		R	360°	1020°/sec	

Y P - X PICK & PLACE ROBOTS

Model	Axes	Structure				Maximum payload (kg)	Cycle time (sec)
		X axis	Y axis	Y axis	R axis		
YP220BX	2 axes	Belt	-	Belt	-	3	0.45
YP320X		Ball screw	-	Belt	-	3	0.57
YP220BXR	3 axes	Belt	-	Belt	Rotation axis	1	0.62
YP320XR		Ball screw	-	Belt	Rotation axis	1	0.67
YP330X		Ball screw	Ball screw	Belt	-	3	0.57
YP340X	4 axes	Ball screw	Ball screw	Belt	Rotation axis	1	0.67

LCM100 Linear conveyor module

Basic specifications	
Model	LCM100-4M/3M/2MT
Drive method	Moving magnet type, Linear motor with flat core
Repeat positioning accuracy	+/-0.015 mm (single slider) ^{Note 1} / width 0.1 mm (mutual difference among all sliders) ^{Note 2}
Scale	Electromagnetic type / resolution 5 µm
Max. speed	3000 mm/sec
Max. acceleration	2G
Max. payload	15kg ^{Note 3} ^{Note 4}
Rated thrust	48N
Total module length	640 mm (4M) / 480 mm (3M) / 400 mm (for 2MT circulation)
Max. number of combined modules	16 (total length: 10240 mm)
Max. number of sliders	16 (when 16 modules are combined)
Min. pitch between sliders	420mm
Mutual height difference between sliders	0.08mm
Max. external size of body cross-section	W 136.5 mm × H 155 mm (including slider)
Bearing method	1 guide rail / 2 blocks (with retainer)
Module weight	12.5kg (4M) / 9.4kg (3M) / 7.6kg (2MT)
Slider weight	2.4 kg / 3.4 kg (when the belt module is used.)
Cable length	3m/5m
Controller	LCC140

Note 1. Repeatability when positioning in the same direction (pulsating).

Note 2. Positioning accuracy in the pulsating when using the position correction function with the RFID.

Note 3. Weight per single slider.

Note 4. When used together with the belt module, the max. payload becomes 14 kg since the parts dedicated to the belt are attached to the slider.

LCC140 Controller

Basic specifications	
Controllable robot	Linear conveyor module LCM series
Outside dimensions	W402.5×H229×D106.5mm
Main body weight	4.8kg
Input power voltage	Single-phase AC200 to 230V +/-10% or less (50/60Hz)
Maximum power consumption	350VA (LCM100-4M 1 slider is driven.)
External input/output	SAFETY
	RS-232C (dedicated to RFID) RS-232C (for HPB / doubles as POPCOM*)
Network option	CC-Link Ver. 1.10 compatible, Remote device station (2 stations)
	DeviceNet™ Slave 1 node EtherNet/IP™ adapter 2 ports
Programming box	HPB, HPB-D (Software version 24.01 or later)

LCM100 Belt module

Basic specifications	
Model	LCM100-4B/3B
Drive method	Belt back surface pressing force drive
Bearing method	1 guide rail / 2 blocks (with retainer)
Max. speed	560mm/sec
Max. payload	14kg
Module length	640mm (4B) / 480mm (3B)
Max. number of sliders	1 slider / 1 module
Main unit maximum cross-section outside dimensions	W173.8mm×H155mm(including slider)
Cable length	None
Controller	Dedicated driver (Included)
Power supply	DC24V 5A
Communication I/F	Dedicated input/output 16 points
Module weight	11.2kg (4B) / 8.8kg (3B)

YA Vertically articulated robots

Type	Model	Application	Number of axes	Payload (kg)	Vertical reach (mm)	Horizontal reach (mm)
6-axis	YA-RJ	Handling (general)	6-axis	1 kg (max. 2 kg*)	909	545
	YA-R3F			3	804	532
	YA-R5F			5	1193	706
	YA-R5LF			5	1560	895
	YA-R6F			6	2486	1422
7-axis	YA-U5F	Assembly / Placement	7-axis	5	1007	559
	YA-U10F			10	1203	720
	YA-U20F			20	1498	910

* When a load is more than 1 kg, the motion range is reduced. Use the robot within the recommended motion range.